

SPECIFICATIONS:

- Digital Display : PV(4-digit, 0.56" high red LED); SV(4-digit, 0.3" high green LED).
- Input Power : AC 110V/220V (+/-10%) 50/60 Hz.
- Sensor Power : DC 12V, 40mA.
- Frequency Response : 10,000 Pulse / Sec.
- Count Range : -999 ~ 9999.
- Counting Mode : Add / Sub; Count / Direction Control;
(CP1;CP2) Add / Add; Quadrature(x4).
- Count Input Set-Up : NPN(Pullhigh resistor); PNP(Pull low resistor) Seleacble.
Logic(10KHz); Contact(100Hz) Selectable.
CMOS(12V); TTL(5V) level Selectable.
- Input Pulse Divider : Programmable 0~9999.
- Input Scale Factor : 0.001 ~ 10.000.
- Operation Function: 8 Modes setting by DIP switch.
- Control Output : 2 Relay(Form C); 2 Solid-state.
- MemoryRetention : No power EEprom.
- Operating Temperature : 0~50 °C.
- Storage Temperature : -10~60 °C.



Typical Application:

Count Measuring

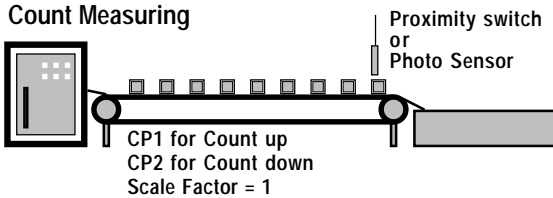

Count to Preset-1 Conveyer slow down,
Count to Preset-2 Conveyer stop (and auto-reset),
next step or next cycle.

Motion Control

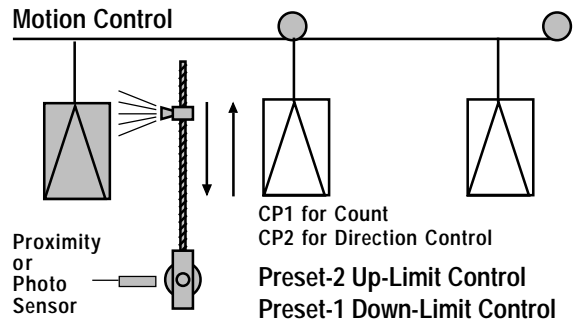

Proximity or Photo Sensor

CP1 for Count
CP2 for Direction Control

Preset-2 Up-Limit Control
Preset-1 Down-Limit Control

Position Control

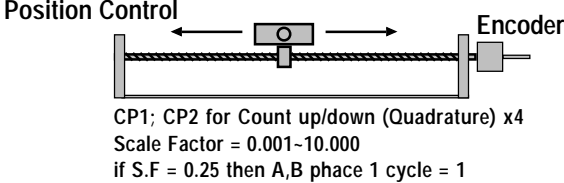

Count to Preset-1 Conveyer slow down,
Count to Preset-2 Conveyer stop (and auto-reset),
next step or next cycle.

Shear Control



Count to Preset-1 Conveyer slow down,
Count to Preset-2 Conveyer stop (and auto-reset),
next step or next cycle.

Length Control

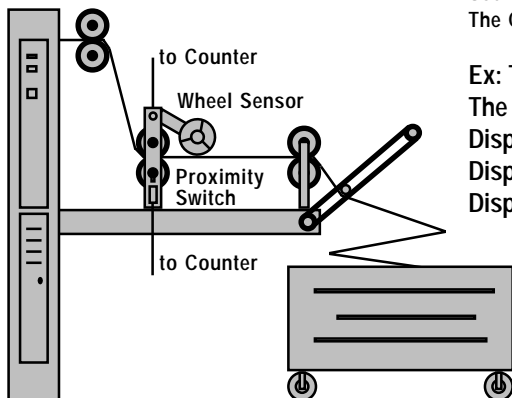

Lost Cost Length-Control :

Use Proximity-Switch or Photo-Sensor to substitute Wheel Sensor.
The Counter's Scale-Factor function let each pulse input response real length.

Ex: The roller 1 Revolution for 325.3mm.
The S.F. set on 0.3253 then the unit will be 1-Meter
Display will show : 32 for 100 revolution.
Display will show : 325 for 1000 revolution.
Display will show : 3253 for 10000 revolution.

Count to Preset-1 to bend left
Count to Preset-2 to bend right

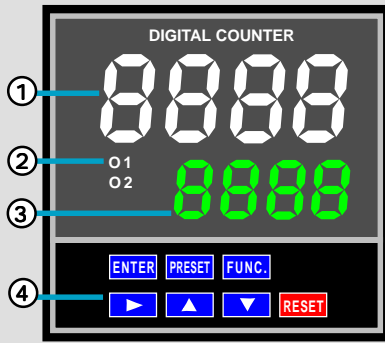

Panel Description:

- ① Red Display: Present Value & Functions.
- ② Output LED(O1;O2): Output Active Indicator.
- ③ Green Display: Set Value & Function's Value.
- ④ Key-Button: Run Setting Functions.

Key-Function description:

ENTER	After completing preset function press this key to save new setting value. If not press this key will be auto-save on no key-press in 10 seconds.
PRESET	Direct press this key for Preset-1 / Preset-2 setting functions. In other function press this key for change functions setting .
FUNC.	press this key with key for setting functions d-t / S-F / S-d . press this key with key for setting functions d-P / P-c / r-t .
	press this key for shift right flash digit .
	press this key for increase flash digit (add 1).
	press this key for decrease flash digit (sub. 1).
RESET	press this key(r-t=0~9) for reset count value or restore P-c value to display (count value).

Example: P-1=1000; P-2 =2000. Now we want change P-2 to 2500.

1th-Press **PRESET** show: P-1 1000 2nd-Press **PRESET** show: P-2 2000 Then press key 2-times to shift digits P-2 2000
Then press key 5-times to increase flashing digit setting value. P-2 2500
Then press **ENTER** key to save new value.

Example: d-t =1.00; S-F = 1.0. S-d = 1. Now we want change S-d to 4

Press **FUNC.** + for setting Delay-Time / Scale Factor / Divider Setting 3 Functions.
show: d-t then press **PRESET** show S-F then press **PRESET** again show S-d
0.100 set delay-time 0.01~99.99 seconds 1000 set pre-scale 0.001~9.999 0000 set divider 1~9999

Then press key 4-times to decrease flashing digit setting value to 4. S-d 0004
Then press **ENTER** key to save new value.

**** When DIP SWITCH PIN-12 ON Pre-scale & Divider will be not to change ****

Example: d-P=0; P-c = 1000. r-t = 1. Now we want change r-t to 5 (press **RESET** key 5-times to reset count value)

Press **FUNC.** + for setting Delay-Time/Scale Factor/Divider Setting Function.
show d-P then press **PRESET** show P-c then press **PRESET** show r-t
0 set decimal point (0~3) 1000 set present-count retrieve (0~9999) 0 set RESET-key press-times (0~9)

Then press key 5-times to increase flashing digit setting value to 5. r-t 5
Then press **ENTER** key to save new value.

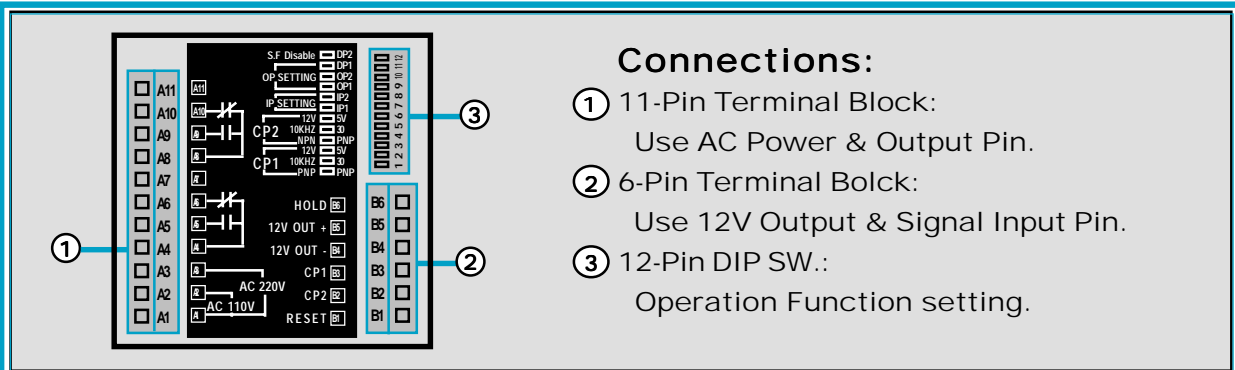

11-Pin Terminal Block Connections:

1. Input Power AC110V Connect to PIN-A1,A2.
2. Input Power AC220V Connect to PIN-A1,A3.
3. Relay 2 Output PIN-A4(COMM);A5(NO);A6(NC).
4. Solid-State 2 Output, PIN-A7 (NPN Open-Collect).
5. Relay 1 Output PIN-A8(COMM);A9(NO);A10(NC).
6. Solid-State 1 Output, PIN-A11 (NPN Open-Collect).

6-Pin Terminal Block Connections:

1. PIN-B1 remote reset (Active with B4).
2. PIN-B2 Count Input CP2.
3. PIN-B3 Count Input CP1.
4. PIN-B4 DC0V (40mA Supply for SENSOR).
5. PIN-B5 DC12V(40mA Supply for SENSOR).
6. PIN-B6 to Count Inhibit (Active with B4).

12-Pin DIP SW.Preset:

- PIN-1-6 Input CP1,CP2 setting;
- PIN-7-8 Count Mode setting;
- PIN-9-11 Operation Mode setting.
- PIN-12 pre-scale & divider disable.

Pin-1(CP1);4(CP2)-OFF, NPN INPUT.

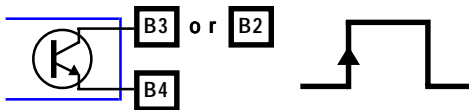

Pin-1(CP1);4(CP2)-ON, PNP INPUT.

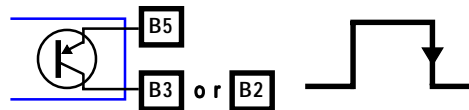

Pin-2(CP1);5(CP2)-OFF, LOGIC INPUT.

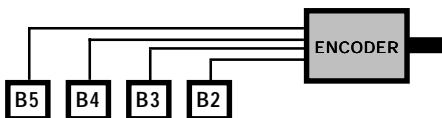

Pin-2(CP1);5(CP2)-ON, CONTACT INPUT.

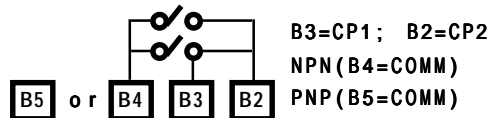

Pin-3(CP1);6(CP2)-OFF, 12-LEVEL INPUT.

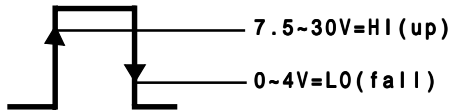

Pin-3(CP1);6(CP2)-ON, 5V-LEVEL INPUT.

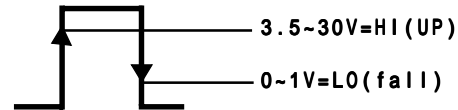

12-Pin DIP SW. Pin-7,8 Counting Mode:

7-OFF;8-OFF, CP1 Add; CP2 Sub.

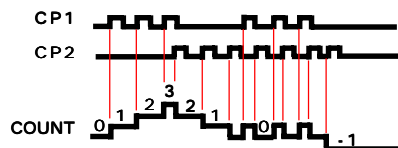

7-ON;8-OFF,CP1 count; CP2 Direction Control.

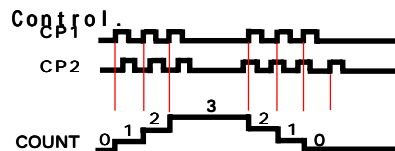

7-OFF;8-ON, CP1 Add; CP±Add.

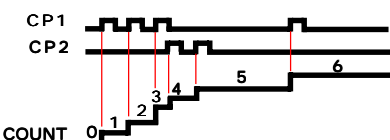

7-ON;8-ON, CP1; CP±j@Quadrature.

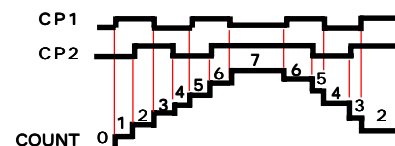

12-Pin DIP SW. Pin-9,10,11. for 8-Modes Operation Setting:

(MODE-0) 9-OFF;10-OFF;11-OFF.
 Latch output at preset-1 & preset-2.
 Manual reset output & reset counting zero.

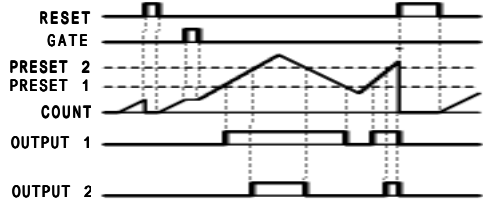

(MODE-1) 9-ON;10-OFF;11-OFF.
 Latch output at preset-1 & preset-2.
 Automatic reset to zero and output 1&2 after delay timer up.

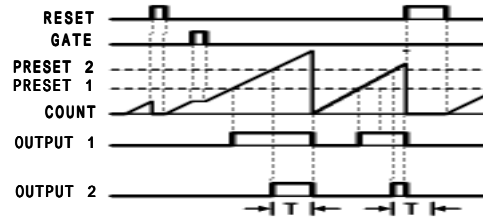

(MODE-2) 9-OFF;10-ON;11-OFF.
 Latch output at preset-1 & preset-2 (with reset counting to zero).
 Automatic reset output 1&2 after delay timer up.

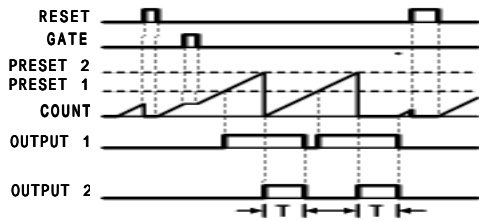

(MODE-3) 9-ON;10-ON;11-OFF.
 Output 1&2 automatic Reset After Delay-Timer up.
 counting not reset to zero.

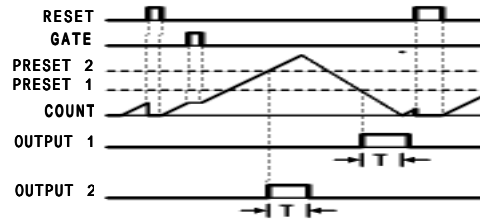

(MODE-4) 9-OFF;10-OFF;11-ON.
 output 1 automatic Reset After Delay-Timer up.
 Latch output 2 at preset-1(>ON,<OFF).

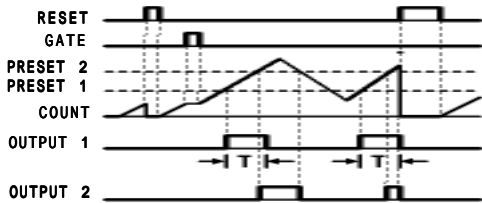

(MODE-5) 9-ON;10-OFF;11-ON.
 output 1 automatic Reset After Delay-Timer up.
 output 2 automatic Reset with reset counting to zero After Delay-Timer up.

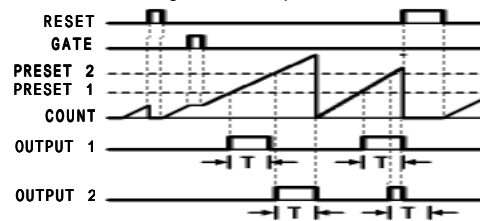

(MODE-6) 9-OFF;10-ON;11-ON.
 output 1 automatic Reset After Delay-Timer up.
 output 2 active with reset counting to zero and output 2 automatic Reset After Delay-Timer up.

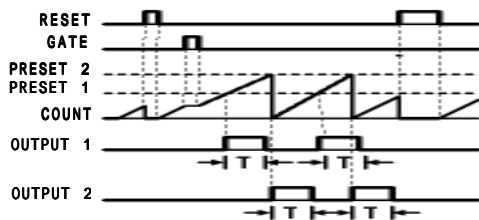

(MODE-7) 9-ON;10-ON;11-ON. Range Compare.
 COUNT<P1,OUT1-ON. COUNT>P2,OUT2-ON
 P1<COUNT<P2, OUT1-OFF, OUT2-OFF.

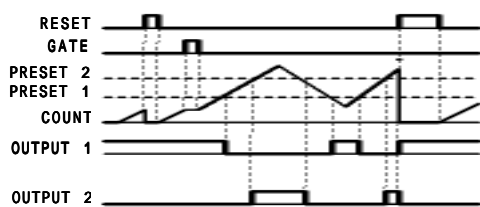

Panel Mounting:

Step 1



Step 2

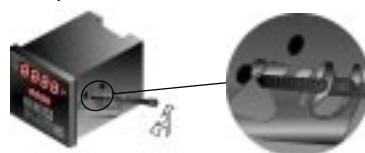

Step 3

