

HN-0802-□
 HN-0802-S-□



Operating Voltage: DC10~30V
 Sensing Distance: 2mm

HN-1705-□



Operating Voltage: DC10~30V
 AC24~250V
 Sensing Distance: 5mm

HN-1805-□



Operating Voltage: DC10~30V
 AC24~250V
 Sensing Distance: 5mm

HN-2305-□



Operating Voltage: DC10~30V
 AC24~250V
 Sensing Distance: 5mm

HN-2507-□



Operating Voltage: DC10~30V
 AC24~250V
 Sensing Distance: 7mm

HN-3010-□



Operating Voltage: DC10~30V
 AC24~250V
 Sensing Distance: 10mm

HN-4020-□



Operating Voltage: DC10~30V
 AC24~250V
 Sensing Distance: 20mm

HN-100-70-□



Operating Voltage: DC10~30V
 AC24~250V
 Sensing Distance: 70cm

HN-2510-□



Operating Voltage: DC10~30V
 AC24~250V
 Sensing Distance: 10mm

HN-1204-□



Operating Voltage: DC10~30V
 Sensing Distance: 4mm

HW-1805-S-□



Operating Voltage: DC10~30V
 Sensing Distance: 5mm

HW-3605-S-□



Operating Voltage: DC10~30V
 Sensing Distance: 5mm

HT-1205-□



Operating Voltage: DC10~30V
 Sensing Distance: 5mm/2mm

HS-0801-□



Operating Voltage: DC10~30V
 Sensing Distance: 1mm

HS-0802-□



Operating Voltage: DC10~30V
 Sensing Distance: 2mm

HS-1202-□



Operating Voltage: DC10~30V
 Sensing Distance: 2mm

HS-1204-□



Operating Voltage: DC10~30V
 Sensing Distance: 4mm

HX-0801-□



Operating Voltage: DC10~30V
 Sensing Distance: 1mm

HX-0802-□



Operating Voltage: DC10~30V
 Sensing Distance: 2mm

HX-1202-□



Operating Voltage: DC10~30V
 AC24~250V
 Sensing Distance: 2mm

<p>HX-1204-□ CE</p>  <p>Operating Voltage: DC10-30V AC24-250V Sensing Distance: 4mm</p>	<p>HX-1805-□ CE</p>  <p>Operating Voltage: DC10-30V AC24-250V Sensing Distance: 5mm</p>	<p>HX-1808-□ CE</p>  <p>Operating Voltage: DC10-30V AC24-250V Sensing Distance: 8mm</p>	<p>HX-3010-□ CE</p>  <p>Operating Voltage: DC10-30V AC24-250V Sensing Distance: 10mm</p>
<p>HX-3015-□ CE</p>  <p>Operating Voltage: DC10-30V AC24-250V Sensing Distance: 15mm</p>	<p>HC-2008-□ HC-3420-□ CE</p>  <p>Operating Voltage: DC10-30V AC24-250V Sensing Distance: 8mm/20mm</p>	<p>HEX-1805-□ HEX-1808-□ CE</p>  <p>Operating Voltage: DC10-30V AC24-250V Sensing Distance: 5mm/8mm</p>	<p>HN-1705-M CE</p>  <p>Operating Voltage: AC/DC12-250V Sensing Distance: 5mm</p>
<p>HN-1805-M CE</p>  <p>Operating Voltage: AC/DC12-250V Sensing Distance: 5mm</p>	<p>HN-2507-M CE</p>  <p>Operating Voltage: AC/DC12-250V Sensing Distance: 7mm</p>	<p>HN-3010-M CE</p>  <p>Operating Voltage: AC/DC12-250V Sensing Distance: 10mm</p>	<p>HN-4020-M CE</p>  <p>Operating Voltage: AC/DC12-250V Sensing Distance: 20mm</p>
<p>HX-1202-M CE</p>  <p>Operating Voltage: AC/DC12-250V Sensing Distance: 2mm</p>	<p>HX-1204-M CE</p>  <p>Operating Voltage: AC/DC12-250V Sensing Distance: 4mm</p>	<p>HX-1805-M CE</p>  <p>Operating Voltage: AC/DC12-250V Sensing Distance: 5mm</p>	<p>HX-1808-M CE</p>  <p>Operating Voltage: AC/DC12-250V Sensing Distance: 8mm</p>
<p>HX-3010-M CE</p>  <p>Operating Voltage: AC/DC12-250V Sensing Distance: 10mm</p>	<p>HX-3015-M CE</p>  <p>Operating Voltage: AC/DC12-250V Sensing Distance: 15mm</p>	<p>HC-2008-M CE</p>  <p>Operating Voltage: AC/DC12-250V Sensing Distance: 8mm</p>	<p>HC-3420-M CE</p>  <p>Operating Voltage: AC/DC12-250V Sensing Distance: 20mm</p>

<p>KN-3015-□ </p>  <p>Operating Voltage: DC10~30V Sensing Distance: 15mm</p>	<p>KW-3610-□ </p>  <p>Operating Voltage: DC10~30V Sensing Distance: 10mm</p>	<p>KX-1808-□ </p>  <p>Operating Voltage: DC10~30V Sensing Distance: 8mm</p>	<p>KC-2010-□ </p>  <p>Operating Voltage: DC10~30V Sensing Distance: 10mm</p>
<p>KX-3020-□ </p>  <p>Operating Voltage: DC10~30V Sensing Distance: 20mm</p>	<p>KC-3425-□ </p>  <p>Operating Voltage: DC10~30V Sensing Distance: 25mm</p>	<p>HN-1705-□ CT </p>  <p>Operating Voltage: DC10~30V AC25~250V Sensing Distance: 5mm</p>	<p>HN-1805-□ CT </p>  <p>Operating Voltage: DC10~30V AC25~250V Sensing Distance: 5mm</p>
<p>HN-2507-□ CT </p>  <p>Operating Voltage: DC10~210V AC24~250V Sensing Distance: 7mm</p>	<p>HN-3010-□ CT </p>  <p>Operating Voltage: DC10~210V AC24~250V Sensing Distance: 10mm</p>	<p>HN-4020-□ CT </p>  <p>Operating Voltage: DC10~210V AC24~250V Sensing Distance: 20mm</p>	<p>HX-0801-□ CT </p>  <p>Operating Voltage: DC10~30V Sensing Distance: 1mm</p>
<p>HX-0802-□ CT </p>  <p>Operating Voltage: DC10~30V Sensing Distance: 2mm</p>	<p>HX-1202-□ CT </p>  <p>Operating Voltage: DC10~30V AC24~250V Sensing Distance: 2mm</p>	<p>HX-1204-□ CT </p>  <p>Operating Voltage: DC10~30V AC24~250V Sensing Distance: 4mm</p>	<p>HX-1805-□ CT </p>  <p>Operating Voltage: DC10~30V AC24~250V Sensing Distance: 5mm</p>
<p>HX-1808-□ CT </p>  <p>Operating Voltage: DC10~30V AC24~250V Sensing Distance: 8mm</p>	<p>HX-3010-□ CT </p>  <p>Operating Voltage: DC10~30V AC24~250V Sensing Distance: 10mm</p>	<p>HX-3015-□ CT </p>  <p>Operating Voltage: DC10~30V AC24~250V Sensing Distance: 15mm</p>	<p>HC-2008-□ CT </p>  <p>Operating Voltage: DC10~30V AC24~250V Sensing Distance: 8mm</p>

HC-3420-□ CT CE

Operating Voltage: DC10~30V
AC24~250V
Sensing Distance: 20mm

HEX-1805-□ CT
HEX-1808-□ CT CE

Operating Voltage: DC10~30V
AC24~250V
Sensing Distance: 5mm/8mm

HX-0801/HX-0802
□ AN/BN CE

Operating Voltage: DC10~30V
Sensing Distance: 1mm/2mm

HX-1202/HX-1204
□ AN/BN CE

Operating Voltage: DC10~30V
Sensing Distance: 2mm/4mm

HX-1805/HX-1808
□ AN/BN CE

Operating Voltage: DC10~30V
Sensing Distance: 5mm/8mm

HX-3010/HX-3015
□ AN/BN CE

Operating Voltage: DC10~30V
Sensing Distance: 10mm/15mm

UX-40R-S CE

Operating Voltage: DC10~30V
Sensing Distance: 40cm

UX-300D-S CE

Operating Voltage: DC10~30V
Sensing Distance: 300cm

UX-2000T-S CE

Operating Voltage: DC10~30V
Sensing Distance: 2000cm

UX-10R-□ CE

Operating Voltage: DC10~30V
Sensing Distance: 10cm

UX-30R-□ CE

Operating Voltage: DC10~30V
Sensing Distance: 30cm

UX-300D-□ CE

Operating Voltage: DC10~30V
Sensing Distance: 300cm

UX-2000T-□ CE

Operating Voltage: DC10~30V
Sensing Distance: 2000cm

UN-15R-□ CE

Operating Voltage: DC10~30V
Sensing Distance: 15cm

UN-30R-□ CE

Operating Voltage: DC10~30V
Sensing Distance: 30cm

UN-200D-□ CE

Operating Voltage: DC10~30V
Sensing Distance: 300cm

UN-200T-□ CE

Operating Voltage: DC10~30V
Sensing Distance: 200cm

US-10R-□ CE

Operating Voltage: DC10~30V
Sensing Distance: 10cm

US-40R-□ CE

Operating Voltage: DC10~30V
Sensing Distance: 40cm

US-200D-□ CE

Operating Voltage: DC10~30V
Sensing Distance: 200cm

US-500T-□ CE

Operating Voltage: DC10~30V
Sensing Distance: 500cm

UY-10R-□ CE

Operating Voltage: DC10~30V
Sensing Distance: 10cm

UY-30R-□ CE

Operating Voltage: DC10~30V
Sensing Distance: 30cm

UY-2MD-□ CE

Operating Voltage: DC10~30V
Sensing Distance: 200cm

UY-3MT-□ CE

Operating Voltage: DC10~30V
Sensing Distance: 300cm

UP-100R CE

Operating Voltage: DC/AC12~240V
Sensing Distance: 100cm/200cm

UP-300D CE

Operating Voltage: DC/AC12~240V
Sensing Distance: 300cm/500cm

UP-1000T CE

Operating Voltage: DC/AC12~240V
Sensing Distance: 1000cm/2000cm

UT-06N-R CE

Operating Voltage: DC12~24V
Sensing Distance: 6mm

UDJ-211-□ CE

Operating Voltage: DC12~24V
Sensing Distance: 8mm

UDJ-311-□ CE

Operating Voltage: DC12~24V
Sensing Distance: 9mm

UDJ-411-□ CE

Operating Voltage: DC12~24V
Sensing Distance: 11mm

UDJ-511-□ CE

Operating Voltage: DC12~24V
Sensing Distance: 12mm

HN-FR CE

Operating Voltage: DC12~24V

HN-FR-1 CE

Operating Voltage: DC12~24V

H-CR-05 CE

Sensing Distance: 4mm

H-CR-05A CE

Setting Distance: 12mm

H-CR-06 CE

Sensing Distance: 4cm

H-CR-06A CE

Sensing Distance: 12mm

H-SP-05 CE

Sensing Distance: 15mm

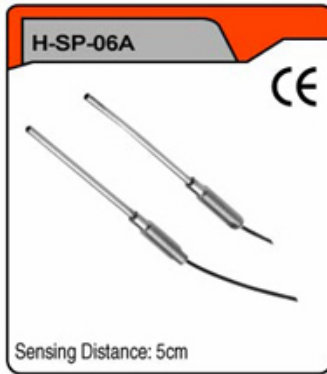
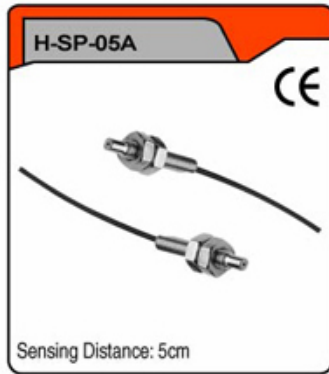

AC/DC Photo Sensor with Built-in Amplifier

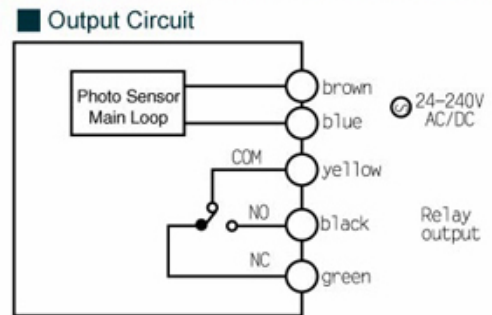

The circuit diagram of DC 3-Wires type/ AC 2-wires type:

NPN DC 3 wires type

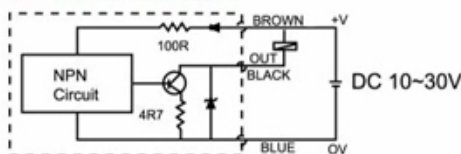

PNP DC 3 wires type

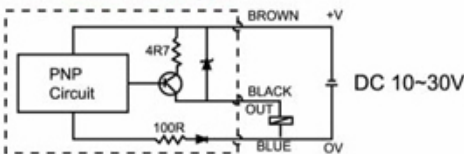

AC 2 wires type

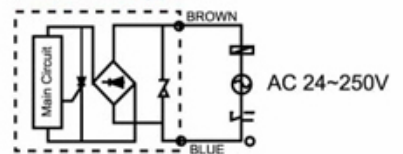

The circuit diagram of AC/DC 2 wires type:

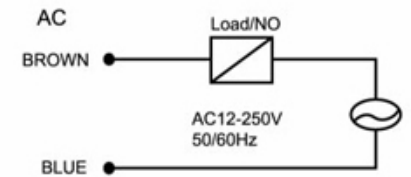
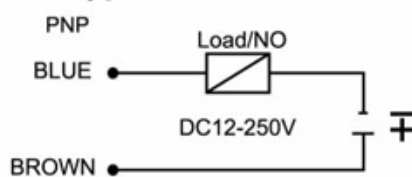
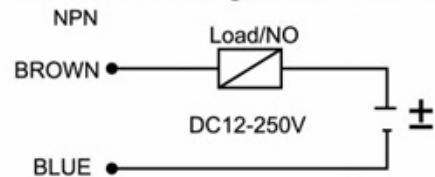

The circuit diagram of Photo Sensor NO/NC type:

Connections

(1) Sender



(2) NPN Wiring Method

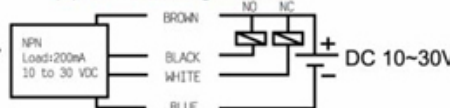

(3) PNP Wiring Method

