

Memo. :

Temperature Controller

Model : Aum-2KND2S

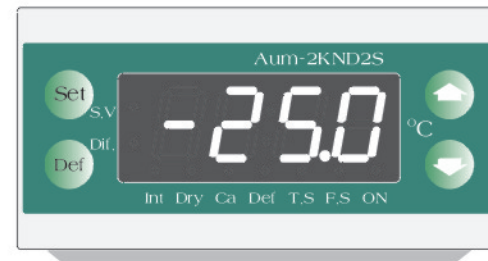

(For Cooling only)

General Purpose of "Aum-2KND2S"

Wiring diagram for "Cooling and Defrosting" mode)

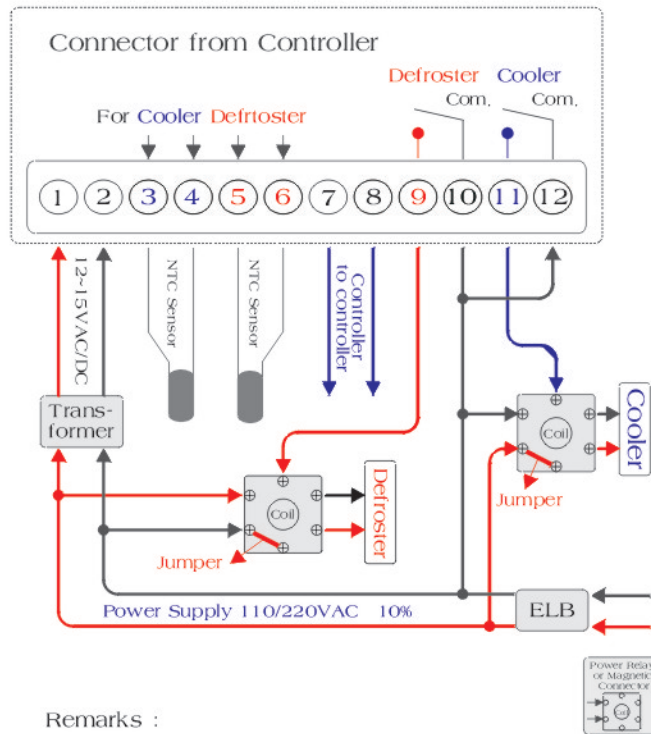

Remarks :

Caution in use

1. Avoid an excessive temperature, humid and shock.
2. Keep the instrument away from the high voltage of a generator, or a motor.
3. Let the end part of a sensor stay toward the top in order to prevent the droplets of water gathering around the sensor.
4. In case of resumption of the electric power, it is recommended to be switched on after 5 seconds to avoid an electrical fault.

Mod. : Aum-2KND2S

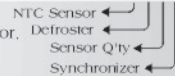

Maxthermo-Gitta Corp.

" Digital Temperature Controller "

Mod. : Aum-2KND2S

----- Operating Manual -----



1. The distinguishable character of this model particularly suits the "Open Show Case" whose several freezers are usually operated by the huge compressor. The unit of this model in which the micro-processor has been installed perfectly performs all the basic functions of refrigeration, and the defrosting function under the regulation of the temperature. When the compressor is turned on, all the linked freezers based on the parallel connection perform the functions individually. But the initiations and the completions of the defrosting function begin at the same time. Especially it is reliable performance is based on a system of the feed back, which can compare the selected set values with the resulted value of its system in order to detect, correct and show the figure up to one decimal place. Hence, the range that can be covered is from -40.0 to 50.0°C .
2. There are functions such as S.V.(The value of selection), Dif.(Differential), Int.(The interval of a defrosting cycle), Dry(The draining time), Def.(The defrosting completion by temperature), T.S (The control of time for the defrosting completion), F.S.(The lamp of sensor fault) and "ON" (The lamp of performance). Every function has a lamp that helps the work of settings conveniently.
3. It is composed of a main body, two sensors and a transformer. The power supply is 12-15VAC/DC. The sensor doesn't require any certain direction. As soon as the power supply and the sensor is switched on, the temperature will be displayed on the window.

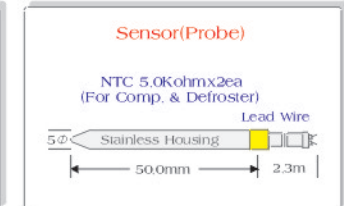
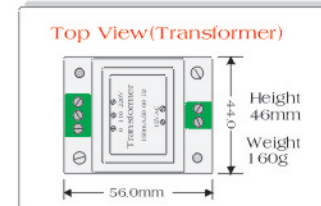
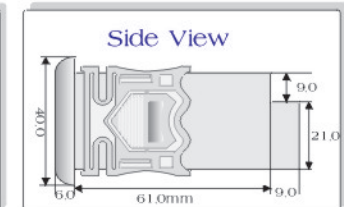

Drilling Template : B.70.0xH.29.0mm(+0.5mm)

Maxthermo-Gitta Corp.

Method of Program Loading

Mod. : Aum-2KND2S

1. Selection Value : Check the S.V. lamp



2. Differential : Check the Dif. lamp



3. Interval(Hour) : Check the Int. lamp



4. Dry(Drain) : Check the Dry lamp

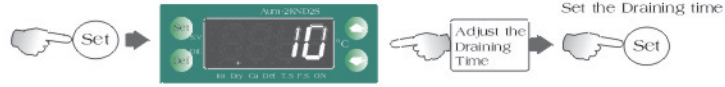

5. Calibration : Check the Ca. lamp

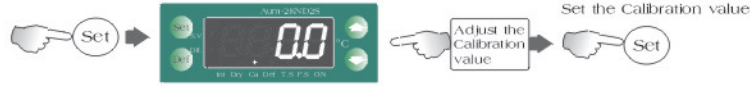

6. Defrost(By temperature) : Check the Def. lamp



7. Stop by time(minite) : Check the T.S. lamp



8. Fault of Sensor : Check the I/O(in/out) lamp

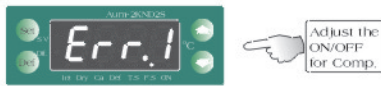

9. Check the Relay(Comp.) ON/OFF



The cooling & De-frosting and draining cycle in the process

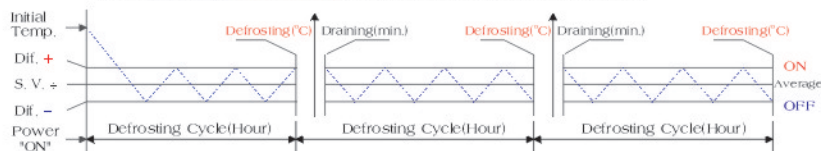

Reference : 1. When the power has been switched off in the process, whatever modes may have been performing, the defrosting cycle always starts to work from the beginning.

- The Aum-2KND2S require the power supply of 12-15VAC/DC. As soon as the sensor for temperature and the power supply is switched on, The present temperature from the sensor will be shown in the window.
- Whenever the 'Set' key is pressed, The next function will be selected. But the defrosting internal needs to be pressed by the 'Set' key and the 'Def' key at the same time.
- Press the 'Set' key to select a function, and then adjust the required value of the direct parameter with the 'Up' key or the 'Down' one. At last, press the 'Set' key again to finalize the selected set value. Otherwise the initial setting of the unit continues to work toward the value of the previous settings.
- A function needs to be corrected, press the 'Up' or the 'Down' one. Consequently a status light of the function will be blanking. It means that the correction is working out now.
- Although either a function has been selected by the 'Set' key, or the set values has been corrected, and finalized by the 'Set' key, there is no change on the window. After 20 seconds, the mode will automatically be returned to a position that the present temperature is shown on the window.
- In case of a manual operation, press the 'Set' key for 5 seconds to start the defrosting function of all the related temperature controllers. In addition, an automatic operation also applies to the same way. The precedent defrosting performances will also be all returned to the mode of compressor when the last temperature controller completes the draining function.
- Right from the moment when the power has been switched on, the defrosting interval repeatedly tracks the setting values of a defrosting function. The actual defrosting time by no means affects the settings of the defrosting interval, in the mean time the 'DEF' will be shown on the window for the extended 10 minutes while the defrosting function and the draining function is performing. And also, the mode of the temperature performs as usual during the extended 10 minutes.
- When the setting of predetermined, defrosting completion is higher than the temperature that the sensor for a defrosting mode detects actually, the defrosting function of either an automatic or the one of a manual starts its operation. On the contrary it is lower than the temperature, the only draining time is controlled. Press the 'Down' key under the mode of present temperature and then, the present temperature of the defrosting sensor will be checked.
- Connect the signal wires of the No.7 and No.8 so as to link a temperature controller to the other one. The way of the connection must be parallel with same numbers.
- The defrosting mode must be based on an 'Electric Heater' only.

Mod. : Aum-2KND2S

No.	Status Light	Mode	Working Range	Initial Settings	Unit	Apply	Definition
1.	(1)	S. V.	-40.0-50.0	5.0	°C	Comp.	S.V. : The value of selection

- Select a function with the 'Set' key, and then adjust a required value of direct parameter with the 'Up' key or the 'Down' one. At last, the 'Set' key must be pressed to finalize the new set value that has just been set by the 'Up' key or the 'Down' one.
- The range of a selected temperature is as follows : $-40.0 < (S.V.) + (Dif.) < 50.0^{\circ}C$

2.	(2)	Dif.	(0.0-12.7)	(1.5)	°C	S. V.	Dif. : Differential
----	-----	------	------------	-------	----	-------	---------------------

- The working range of a differential simultaneously applies to both set values, which can be sum up with by this way of (S.V.+Dif.). For instance, the value of a selected temperature is 5.0°C, and the selected value of a differential is 1.5°C. Eventually the working range of a differential is from 3.5°C to 6.5°C.
- At least 0.3°C is recommended to protect a mechanical system from an excessive operation.

3.	(3)	Int.	0 - 255	n004	Hour	Defrosting	Int. : Interval of defrosting cycle
----	-----	------	---------	------	------	------------	-------------------------------------

- Press the 'Set' key and the 'Def' key at the same time. Then, check whether the light of an interval has been turned on.
- Set the interval values of a defrosting interval with the 'Up' key or the 'Down' one.
- Set the zero-noi as a value of a defrosting interval in case a defrosting mode is a manual.

4.	(4)	Dry	0 - 15	10	Minute	Draining Time	* DRY : Drain
----	-----	-----	--------	----	--------	---------------	---------------

- The purpose of this function is to get rid of the droplets of water, which tends to remain in the evaporating sector after the completion of a defrosting performance.
- Right after the draining time ran out, the compressor will keep to a position from which its function is automatically carried out as per a waiting mode until the final freezers have completed the draining time.

5.	(5)	Ca.	+/- (0.0-6.3)	0.0	°C	Sensors	Ca. : Calibration
----	-----	-----	---------------	-----	----	---------	-------------------

- The purpose of this function is to correct the differences of present temperature that happens when the led wire of a sensor for the temperature has been extended considerably.
- The extended sensor requires being installed in a long distance, keep it away from a generator or an electrical noise.

6.	(6)	Def	-40.0-50.0	8.0	°C	DC	DC : Defrosting completion
----	-----	-----	------------	-----	----	----	----------------------------

- Set a predetermined value of the temperature to rule the completion of a defrosting function that is related to a sensor for the defrosting function of an evaporating sector.
- The defrosting function is performing based on the defrosting interval. Meanwhile, it reaches the predetermined value of a defrosting completion, which means that its function is to be completed.
- As soon as the defrosting function is completed automatically, the droplets remaining all around the evaporating sector will be dried out by the performance that is ruled by the set values of a draining time.
- No matter what either one of the automatic defrosting function and the manual defrosting function may be working on, press the 'Def' key for 3 seconds to stop the defrosting function.
- While the defrosting function is performing, the defrosting light will be lit.

7.	(7)	T. S.	01 - 63	30	Minute	Defrosting	T.S. : Defrosting completion by time set
----	-----	-------	---------	----	--------	------------	--

- When the led wire of a sensor for a defrosting function has been disconnected, the mode of a temperature control in terms of a defrosting completion turns automatically into the mode of a time control upon the defrosting completion. Thereafter, the defrosting function fulfills its role according to the set values of time.

8.	(8)	F. S.	-	-	-	-	Fault of Sensor
----	-----	-------	---	---	---	---	-----------------

- When the led wire of a sensor for the compressor has been disconnected, the light of a fault is lit and immediately the 'Err.1' and a sensor for the defroster 'Err.2' will be shown on the display.
- Meanwhile, the compressor keeps on working, regardless of changes of temperature, and also the defrosting function work as usual. When the led wire of a sensor for a defrosting function has been disconnected, the light of a fault will be lit while the defrosting and the function of a draining time is performing. But the compressor works on continuously. In addition, the defrosting function stops working due to the function of a time control.

9.	(9)	ON	-	-	-	-	Comp. Comp. : Compressor
----	-----	----	---	---	---	---	--------------------------

- The light is lit while the compressor is performing.